

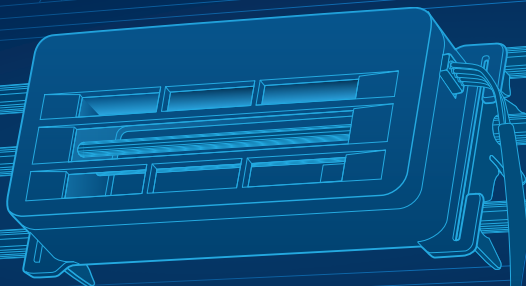

TADIRAN AIROW 3™

Hydrogen Peroxide Aerosol Disinfector

Installation Manual



Innovative air purification solution

Model: TADIRAN AIROW 3™

Global Markets

Table of Contents

Safety.....	3
Meet TADIRAN AIROW 3™.....	4
Device Specifications.....	5
Included Parts.....	6
Installation.....	7
Verification.....	11
Warranty.....	13
Patent Information.....	14

Safety



This Device is a Class III Equipment

- This Class III appliance must only be powered with short-circuit proof, safety extra low voltage (SELV) corresponding to the marking on the device.
- This Class III device must only be supplied at SELV.
- This Class III device is not intended for use by persons (including children) with reduced physical, sensory or mental capabilities, or lack of experience and knowledge unless they have been given supervision or instruction concerning the use of the device by a person responsible for their safety. Children should be supervised to ensure that they do not play with the device.
- This Class III device is not intended to be installed as a stand-alone device. It is always installed in the indoor part of an air conditioner (the receiving equipment).
- This Class III installation manual is intended to provide all required instructions on how to install the purifier into the indoor part of an air conditioner.
- Verify that the installation is performed in accordance with the installation diagrams.
- Means for disconnection of the supply mains must be incorporated in the fixed wiring following the wiring rules.
- The mains to the DC power supply has a contact separation in all poles that provide full disconnection under overvoltage category III conditions, the means for disconnection is a quick disconnect mains plug.
- Note that the device contains metal parts that carry high voltage. **Never insert a finger or any other unprotected body part into the device! Use only isolated tools when servicing or testing the device!**

Please follow the installation procedure stated below.

Meet TADIRAN AIROW 3™

The TADIRAN AIROW 3™ device is designed to be implemented in High-Wall air conditioning systems, fan coils, heat pump PTACs, ductless mini splits and VRF ductless split systems. It is installed on the air inlet side of the coil, in the indoor unit. TADIRAN AIROW 3 reduces bacteria, viruses and molds* in the air and improves the air quality in the conditioned space. The device helps with preventing the development of pollutants within the air conditioning system.

The principle of operation is based on the formation of an electric field between a metal wire, located in the center of the device, and two rectangular metal plates that face the metal wire.

The following illustration outlines the TADIRAN AIROW 3 device.

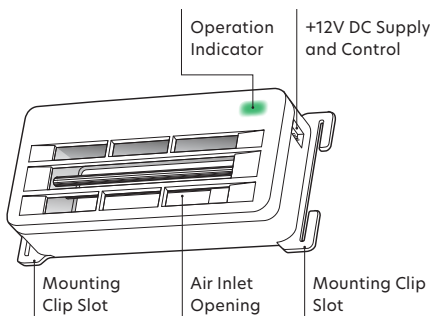

*TADIRAN AIROW 3 reduced detected virus (SARS-CoV-2) aerosol levels by 99.93% within 60 min (18 cubic meter test chamber), detected Bacteria *Staphylococcus epidermidis* aerosol levels by 99.994% within 90 min (1 cubic meter test chamber) and reduced 99.4% of blue mold aerosolized in within 3 hours (25 cubic meter chamber).

General Note: All figures shown in this manual are for reference only.

Device Specifications

Parameters	Value
Weight	100g
Dimensions	96X42X26mm (Net)
Housing Material	ABS Plastic, White Color
Operation Temperature	-5°C to +55°C
Operation Humidity (Non-Condensing)	20%-80%
Input Voltage	12 VDC \pm 10%
Power Consumption	1 W Max
Indication LED	Green - Proper Operation Red - Failure
Maintenance	Zero Maintenance
Ozon Emission	\leq 5 ppb
Hydrogen Peroxide Level	\leq 15ppb

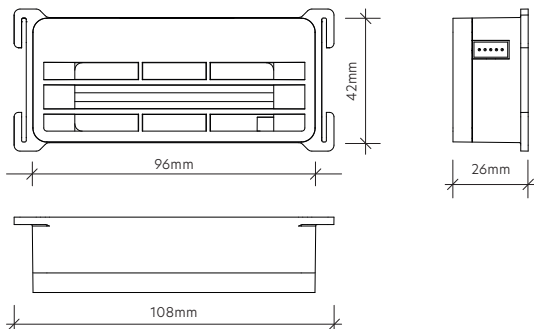

Included Parts

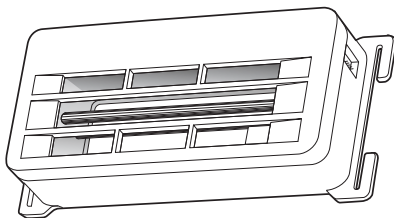

TADIRAN AIROW 3™ Device

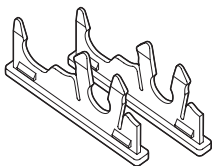

Mounting Clips for 5mm
Tube Coil

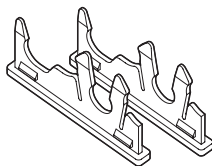

Mounting Clips for 7mm
Tube Coil

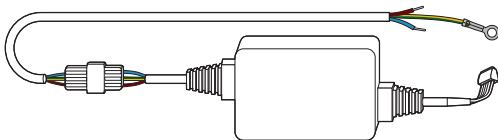

TADIRAN AIROW 3 Power Supply 110/220VAC to 12 VDC

The TADIRAN AIROW 3™ device also comes with 3-year warranty card and Safety sticker.



Safety sticker

NOTE!

Only qualified and licensed HVAC technicians may install this device. The TADIRAN AIROW 3 device, power supply and additional accessories should be disconnected from any electric supply when touching their surface or inner parts. Tadiran will not be liable for any loss or damage in any case of misuse or installation by a non-qualified person or not in compliance with the directions included in this manual. Tadiran does not claim that the TADIRAN AIROW 3™ will ensure consumers using the device will not contract biological pathogens. Consumers should continue to follow guidance from governmental health organizations and certified health professionals about preventative measures.



Disconnect the mains supply of the air conditioner before performing the installation or before servicing the device.

Installation

Before Installation, unplug the air conditioner from the mains supply.

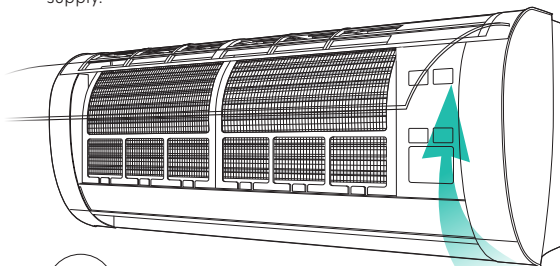

1

Open the indoor unit's front panel.

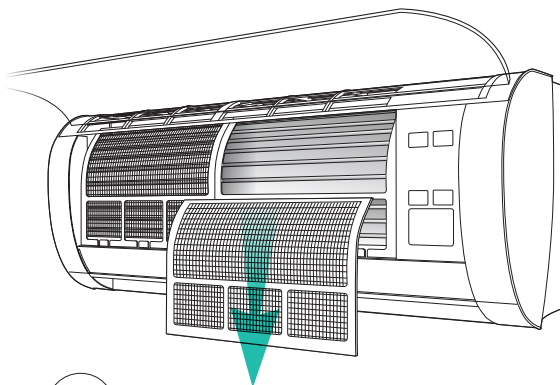

2

Remove the air filter.

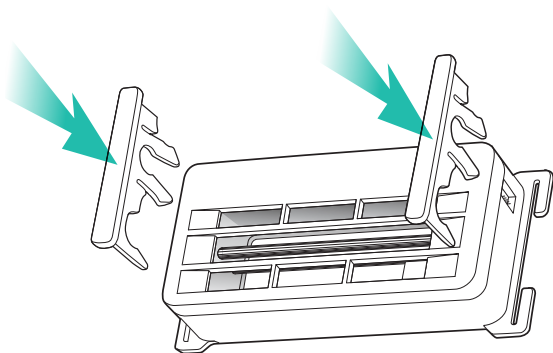

3

Insert the proper installation clips (5mm or 7mm), on both sides of the unit as shown in the drawing above.

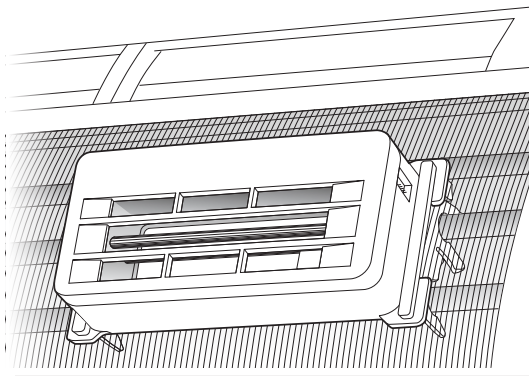

4

Mount the TADIRAN AIROW 3™ device, using the mounting clips, onto the indoor unit's coil, at the upper right corner of the coil.

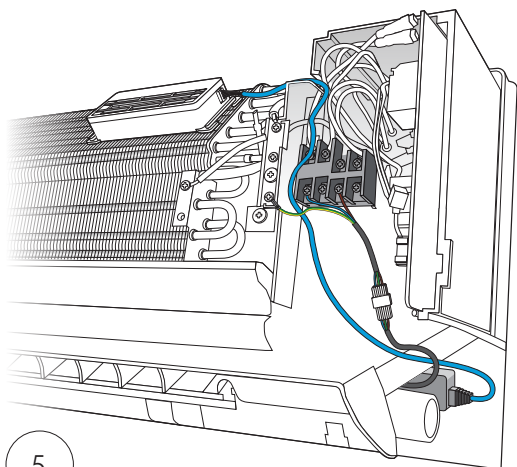

5

After the unit is installed on the coil, disassemble the front panel of the indoor unit.

- Mount the power supply in the back of the indoor unit.
- Connect the plug of the DC cable of the power supply to TADIRAN AIROW 3™ unit.
- Connect the AC cable of the power supply to the terminal block of the indoor unit.

Brown wire:

- In fix-speed systems to the compressor 230 or 110 VAC command.
- In variable speed systems (inverter) or fix speed systems where the compressor command is not available - to the mains supply.

Blue wire: To the neutral terminal.

Yellow/Green wire: To ground.

- Reassemble the front panel.

Verification

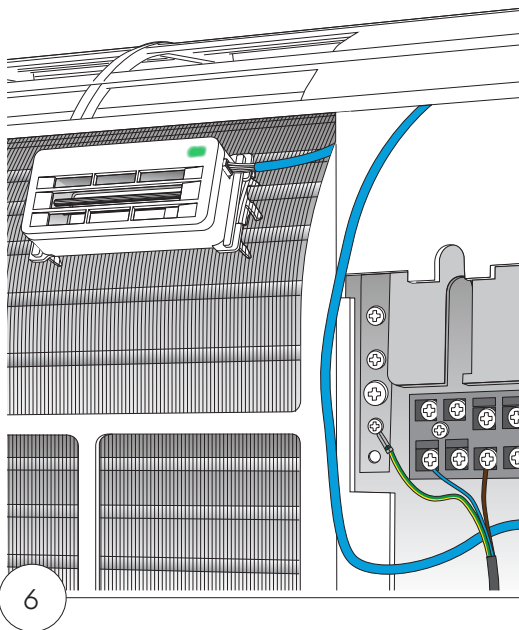

- Plug the air conditioner to the mains supply and turn on the air conditioner.
- The green LED indicator on the TADIRAN AIROW 3™ lights up, indicating normal device operation.
- Place the safety sticker in a visible and accessible location, near the terminal board.

The following is a diagram of the electrical connections, describing the TADIRAN AIROW 3™ connections to the terminal block of the indoor unit.

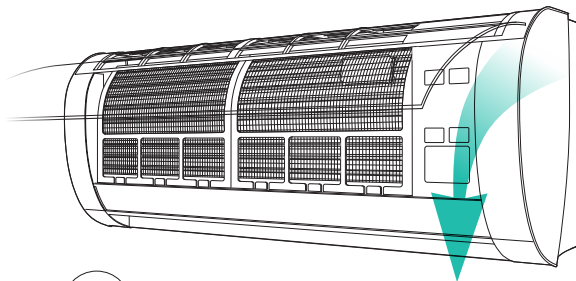
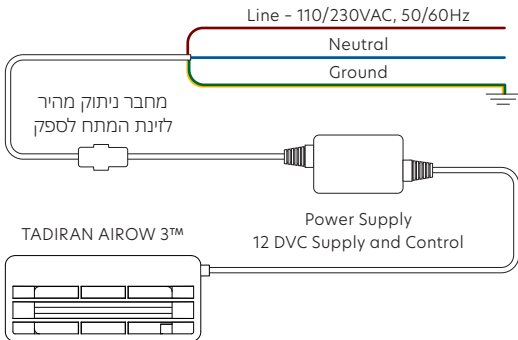

7

Place the air filters back.
Close the front panel.

Installation is Completed!

TADIRAN AIROW 3™ Warranty Registration

3 Years Coverage

To ensure a valid 3 years warranty, don't forget to register your TADIRAN AIROW 3™ upon installation*.

1. Go to www.tadiran-international.com/warranty
2. Enter your details and press "Submit"
3. You will receive a confirmation via email

Need Help?

Contact your local distributor for any further questions.

*Only qualified and licensed HVAC technicians may install this device



TADIRAN AIROW 3™



Indication for Use

This product is not a medical device and is not intended to be used as a medical device or to cure any disease or condition, nor should it be used in the mitigation, treatment, or prevention of any disease or condition.

Legal Notice

Only qualified and licensed HVAC technicians may install this device. The TADIRAN AIROW 3™ device, power supply and additional accessories should be disconnected from any electric supply when touching their surface or inner parts. Tadiran will not be liable for any loss or damage in any case of misuse or installation by a non-qualified person or not in compliance with the directions included in this manual. Tadiran does not claim that the TADIRAN AIROW 3™ will ensure consumers using the device will not contract biological pathogens. Consumers should continue to follow guidance from governmental health organizations and certified health professionals about preventative measures.

Patent Information



Patented Method of Use

Europe Patent NO.3743196 (Albania, Austria, Belgium, Bulgaria, Croatia, Cyprus, Czech Republic, Denmark, Estonia, Finland, France, Germany, Greece, Hungary, Iceland, Ireland, Italy, Latvia, Lithuania, Luxembourg, Macedonia, Malta, Monaco, Netherlands, Norway, Poland, Portugal, Romania, San Marino, Serbia/Montenegro, Slovakia, Slovenia, Spain, Sweden, Switzerland, Turkey, United Kingdom)
China Patent NO. CN 112739389
Israel Patent NO. 262022
South Korea Patent NO. 10-2288840



Assembled In Romania



Air Safe
Zone



TADIRAN AIROW™

Any Space
Can be a Safe
Place



TADIRAN



TADIRAN

Tadiran Air Technologies Ltd.

Laskov St. 1, Afula 1834159 Israel | www.tadiran-international.com